



VP 80

PLATINUM DESIGN

NOWA ERA OKIEN

PAKIET KORZYŚCI



DESIGN

Profile o prostych liniach i nowoczesnym designie. Okna wyglądem przypominające ślusarkę aluminiową. Wąska przyłga 9 mm - unikalne rozwiązanie na rynku, wizualne nawiązanie do okien aluminiowych przy zachowaniu wszystkich zalet okna PVC.



ENERGOOSZCZĘDNOŚĆ

Linia dedykowana do domów energooszczędnych i pasywnych.



WIĘCEJ ŚWIATŁA

Wysokość złożenia 112 mm.

VP 80 PLATINUM DESIGN

OKNO

Wąskie profile PCV zapewniające więcej światła.

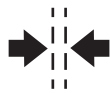

Trzy uszczelki obwodowe.

Głębokość skrzydła 80 mm.

Akustyka: szklenie do 54 mm pozwala zastosować szyby zapewniające komfort akustyczny.

Głębokość zabudowy ramy 76 mm.

Profile o prostych liniach i nowoczesnym designie. Okna wyglądem przypominające ślusarkę aluminiową.

Okucia obwiedniowe ze specjalną powłoką antykorozyjną Roto Sil Nano, wyposażone w zaczep antywyważeniowy, blokadę uchylu, blokadę błędnego położenia klamki oraz mikrowentylację. Opcjonalnie: okucia ukryte DESIGNO i antywyważeniowe klasy RC1 oraz RC2.

Dwukomorowy pakiet szybowy 4/18/4/18/4 $U_g = 0,5 \text{ W/m}^2\text{K}$, opcjonalnie: szkło bezpieczne, antywłamaniowe, dźwiękochłonne, ciepła ramka.

Technologia 6-komorowa: doskonała izolacja termiczna zapewniająca redukcję kosztów ogrzewania.

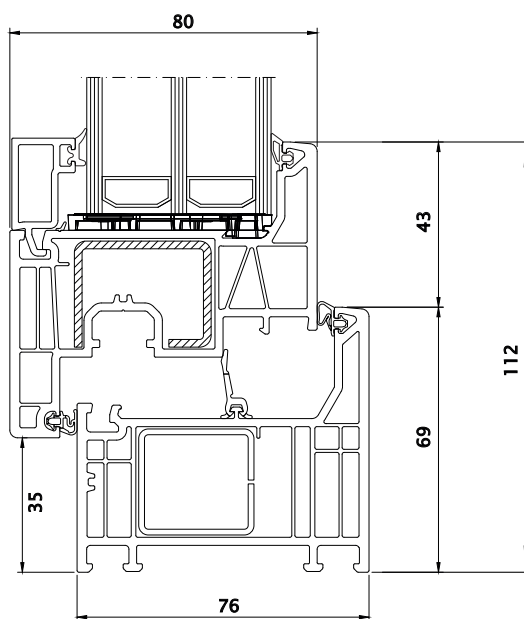

$U_w =$
0,75 $\text{W/m}^2\text{K}^*$

*Dla okna referencyjnego 1,23 m x 1,48 m, $U_g = 0,5 \text{ W/m}^2\text{K}$ SWISS ULTIMATE

Klamka okienna i osłonki na zawiasy w różnorodnej stylistyce i gamie kolorystycznej.



PLATINUM OPTIMA

DRZWI HST

Głębokość zabudowy 175 mm.

Dwukomorowy pakiet szybowy zespolony ze szkłem niskoemisyjnym o grubości do 48 mm, opcjonalnie szkło bezpieczne, antywłamaniowe, dźwiękochłonne, ciepła ramka.

Okucie podnosząco-przesuwne.

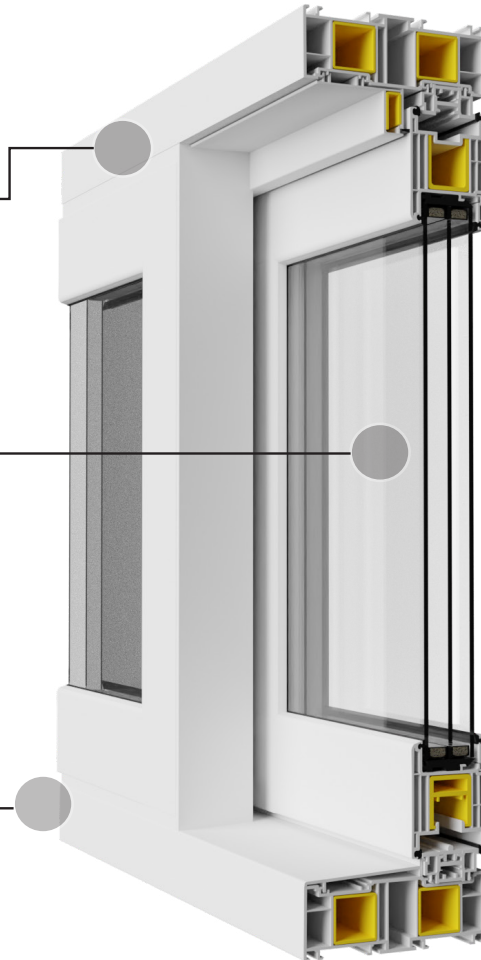

SCHEMATY DRZWI



SCHEMAT A

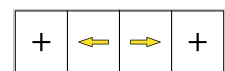

SCHEMAT C-WARIANT

Maksymalnie czteroskrzydłowe konstrukcje, w których dwa skrzydła mogą być przesuwane w płaszczyźnie HS, tworząc dużą otwartą przestrzeń użytkową.

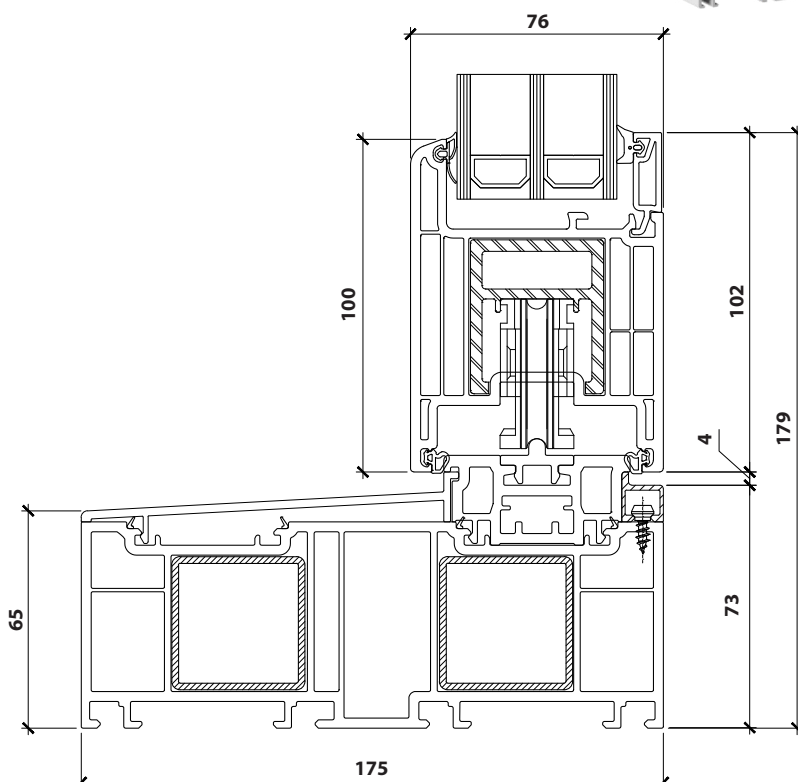





Spójny design
dla Twojego
domu



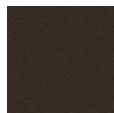

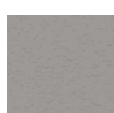

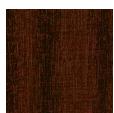

STANDARD

	003 BIAŁY (BARWIONY W MASIE)		025 CIEMNY DĄB		043 GRAFITOWO - CZARNY MAT		048 CIEMNO- SZARY GŁADKI		072 ANTRACYT
	109 WINCHESTER		110 ŻŁOTY DĄB		154 ORZECH		653 ALUX DB 703		

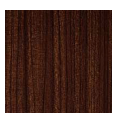
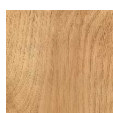
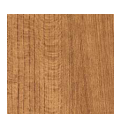
PREMIUM

	004 SZARY		006 CIEMNO- ZIEŁONY		008 CZEKOLADOWO- BRĄZOWY		012 CZARNO- BRĄZOWY		019 BIAŁY
	044 BRĄZOWO- SZARY MAT		068 POPIEL		076 WINNO- CZERWONY		079 GRANATOWY		085 POSĄGOWA ZIELEŃ
	096 KREMOWY		100 KRYSTALICZNA BIEL		103 CIEMNO- SZARY MAT		114 BETONOWO- SZARY		116 ISKRZĄCY BRĄZ
	122 JASNO- SZARY GŁADKI		138 BRĄZ		139 SREBRO		184 ALUX SZARE ALUMINIUM		358 BIAŁY MAT
	625 GRANIT GŁADKI		649 KAMIENNY GŁADKI		651 SZARY GŁADKI		665 SZARY AGAT		667 SZARY BAZALT
	907 JASNO- SZARY		911 SZARY ALUMINIUM GŁADKI		921 TRAFFIC CZARNY GŁADKI		925 JASNY ALUMINIUM		

NATURAL WOOD

	026 MAHOŃ		047 DĄB WOODC TURNER MIODOWY		143 SZARY CEDR		144 MACORE		145 IRLANDZKI DĄB
	146 RUSTYKALNA WIŚNIA		402 DAGLEZJA		656 CHERRY AMARETTO		663 ORZECH BALSAMICZNY SORRENTO		686 CIEMNO-SZARY STYLO
	690 GRAFITOWO- CZARNY STYLO		694 DĄB SHEFFIELD JASNY						

VIDOK.COM
OKNA I DRZWI

PRODUCENT OKIEN I DRZWI Z DREWNA, PVC I ALUMINIUM
VIDOK Sp. z o.o. Rudna Mała 75, 36-054 Mrowla, Polska
biuro@vidok.com | REGON: 690379060 | NIP: 813-10-86-710

